

JBL

**SURROUND CINEMA
SPEAKERS**

SCS300.7

OWNER'S GUIDE

READ FIRST!

Important Safety Precautions!

CAUTION	
RISK OF ELECTRIC SHOCK DO NOT OPEN	
<p>CAUTION: To reduce the risk of electric shock, do not remove cover (or back). No user-serviceable parts inside. Refer servicing to qualified service personnel.</p>	
<p>CAUTION: To prevent electric shock, do not use this (polarized) plug with an extension cord, receptacle or other outlet unless the blades can be fully inserted to prevent blade exposure.</p>	
	<p>The lightning flash with arrowhead symbol, within an equilateral triangle, is intended to alert the user to the presence of uninsulated "dangerous voltage" within the product's enclosure that may be of sufficient magnitude to constitute a risk of electric shock to persons.</p>
	<p>The exclamation point within an equilateral triangle is intended to alert the user to the presence of important operating and maintenance (servicing) instructions in the literature accompanying the appliance.</p>

1. Read these instructions.
2. Keep these instructions.
3. Heed all warnings.
4. Follow all instructions.
5. Do not use this apparatus near water.
6. Clean only with a dry cloth.
7. Do not block any ventilation openings. Install in accordance with the manufacturer's instructions.
8. Do not install near any heat sources such as radiators, heat registers, stoves or other apparatus (including amplifiers) that produce heat.
9. Do not defeat the safety purpose of the polarized or grounding-type plug. A polarized plug has two blades with one wider than the other. A grounding-type plug has two blades and a third grounding prong. The wide blade or the third prong are provided for your safety. If the provided plug does not fit into your outlet, consult an electrician for replacement of the obsolete outlet.
10. Protect the power cord from being walked on or pinched, particularly at plugs, convenience receptacles and the point where they exit from the apparatus.
11. Only use attachments/accessories specified by the manufacturer.
12. Use only with the cart, stand, tripod, bracket or table specified by the manufacturer or sold with the apparatus. When a cart is used, use caution when



moving the cart/apparatus combination to avoid injury from tip-over.

13. Unplug this apparatus during lightning storms or when unused for long periods of time.
14. Refer all servicing to qualified service personnel. Servicing is required when the apparatus has been damaged in any way, such as power-supply cord or plug is damaged, liquid has been spilled or objects have fallen into the apparatus, the apparatus has been exposed to rain or moisture, does not operate normally, or has been dropped.
15. Do not use attachments not recommended by the product manufacturer, as they may cause hazards.
16. This product should be operated only from the type of power source indicated on the marking label. If you are not sure of the type of power supply to your home, consult your product dealer or local power company. For products intended to operate from battery power, or other sources, refer to the operating instructions.
17. If an outside antenna or cable system is connected to the product, be sure the antenna or cable system is grounded so as to provide some protection against voltage surges and built-up static charges. Article 810 of the National Electrical Code, ANSI/NFPA 70, provides information with regard to proper grounding of the mast and supporting structure, grounding of the lead-in wire to an antenna discharge unit, size of grounding conductors, location of antenna-discharge unit, connection to grounding electrodes, and requirements for the grounding electrode. See Figure A.

Figure A.
Example of Antenna Grounding as per National Electrical Code ANSI/NFPA 70

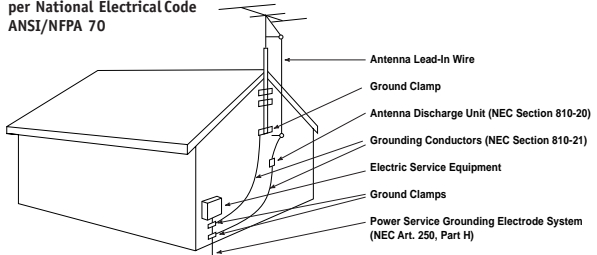

18. An outside antenna system should not be located in the vicinity of overhead power lines or other electric light or power circuits, or where it can fall into such power lines or circuits. When installing an outside antenna system, extreme care should be taken to keep from touching such power lines or circuits, as contact with them might be fatal.

19. Do not overload wall outlets, extension cords, or integral convenience receptacles, as this can result in a risk of fire or electric shock.
20. Never push objects of any kind into this product through openings, as they may touch dangerous voltage points or short-out parts that could result in a fire or electric shock. Never spill liquid of any kind on the product.
21. Do not attempt to service this product yourself, as opening or removing covers may expose you to dangerous voltage or other hazards. Refer all servicing to qualified service personnel.
22. When replacement parts are required, be sure the service technician has used replacement parts specified by the manufacturer or that have the same characteristics as the original part. Unauthorized substitutions may result in fire, electric shock or other hazards.
23. Upon completion of any service or repairs to this product, ask the service technician to perform safety checks to determine that the product is in proper operating condition.
24. The product should be mounted to a wall or ceiling only as recommended by the manufacturer.

THANK YOU FOR CHOOSING JBL

For more than 50 years, JBL has been involved in every aspect of music and film recording and reproduction, from live performances to the recordings you play in your home, car or office.

We're confident that the JBL system you have chosen will

provide every note of enjoyment that you expected – and that when you think about purchasing additional audio equipment for your home, car or office, you will once again choose JBL.

Please take a moment to register your product on our

Web site at www.jbl.com. It enables us to keep you posted on our latest advancements, and helps us to better understand our customers and build products that meet their needs and expectations.

JBL Consumer Products

INCLUDED

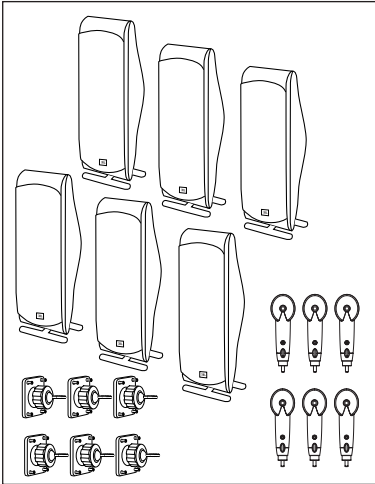

Six satellites for left, right and surrounds. Wall-mount brackets. Shelf stands. Floor stand adaptors.

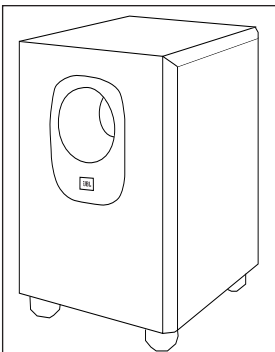

Powered subwoofer.

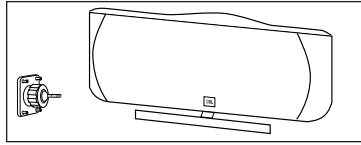

One center channel speaker with shelf stand and wall-mount bracket.

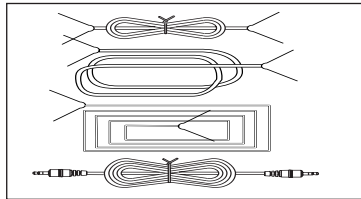

Three 20' (6m) speaker cables for connection to front, left, center and right speakers, or to subwoofer when speaker-level connections are used (see page 9).

Two 15' (4.6m) speaker cables for connection from subwoofer to front speakers when speaker-level connections are used (see p. 9).

Four 40' (12m) speaker cables for connection from receiver to rear satellites.

One 15' (4.6m) RCA interconnect cable for connection from receiver to subwoofer's LFE input.

Hardware Bag A containing screws for the shelf stands. Hardware Bag B containing screws for the floor stand adaptors. Parts for the wall-mount brackets: **1** Metal Nut, **2** Molded Nut, **3** Ball and Shaft, **4** Attachment Plate, **5** Metal Bar. (User must supply four #10 pan-head wood screws **6** at least one inch long, per speaker. See page 6.)

SPEAKER PLACEMENT

FRONT SPEAKERS

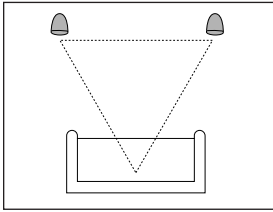

CENTER CHANNEL SPEAKER

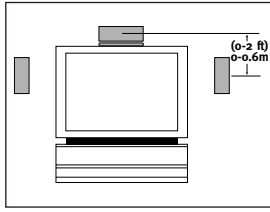

SUBWOOFER

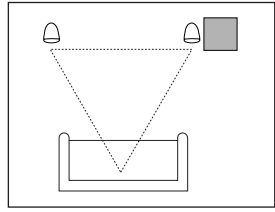

SURROUND SPEAKERS

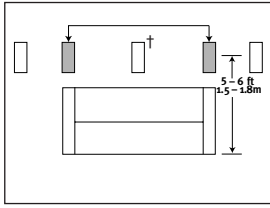
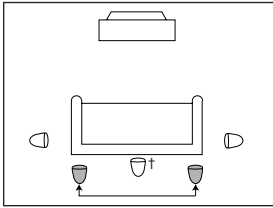

† Single surround back speaker may be used with 6.1 receivers and processors.

Alternate placement for surround speakers when only 5.1 channels are used; required placement for surround back speakers in 7.1-channel systems.

The front speakers should be placed the same distance from each other as they are from the listening position. They should be placed at about the same height from the floor as the listeners' ears will be, or they may be angled toward the listeners.

The center channel speaker should be placed slightly behind the front left and right speakers, and no more than two feet above or below the tweeters of the left and right speakers. It is often convenient to set the center speaker on top of the television set, as shown in the drawing.

The SCS300.7 speaker system may be used in 5.1-, 6.1- or 7.1-channel applications. In 5.1-channel applications, two of the surround speakers should be placed slightly behind the listening

position and, ideally, should face each other and be at a level higher than the listeners' ears. If that is not possible, they may be placed on a wall behind the listening position, facing forward. In 6.1-channel applications, two of the surround speakers should be placed in the side positions, and a single surround back speaker should be placed on the wall behind the listening position. In 7.1-channel applications, place two of the surround speakers in the side positions, and place the two surround back speakers on the rear wall.

In Dolby® Digital and DTS® systems, it is best to aim all of the speakers (except the subwoofer) toward the listening position at about ear-level height. In systems where only analog surround processing (such as Dolby

Pro Logic*) is available, it may be preferable to aim the speakers straight out from the wall to obtain a more diffuse sound.

The low-frequency material reproduced by the subwoofer is mostly omnidirectional, and this speaker may be placed in a convenient location in the room. However, bass reproduction will be maximized when the subwoofer is placed in a corner along the same wall as the front speakers. Experiment with subwoofer placement by temporarily placing the subwoofer in the listening position and moving around the room until the bass reproduction is best. Place the subwoofer in that location.

MOUNTING OPTIONS

SATELLITES AND SURROUNDS

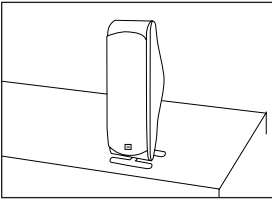

On shelves.

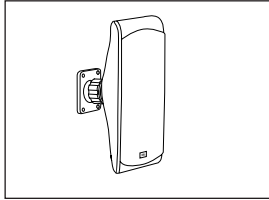

On the wall. Wall brackets are included.

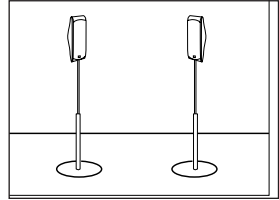

On optional stands.

ATTACHING THE SHELF STAND TO THE SPEAKER

Prepare the speaker wire as described on page 7. Thread the two conductors through the two holes in the stand bracket. Make sure to preserve the proper polarity (+ and – connections) by threading the positive conductor through the hole on

the left, and the negative conductor through the hole on the right looking at the front of the stand. Push down on the red speaker terminal and insert the bare end of the positive wire into the hole under the red cap. Release the cap, and tug gently on the wire to make sure that the connection is snug. Follow the same procedure to connect the negative wire to its terminal.

Gently pull the slack out of the wire and screw the shelf

stand onto the back of the speaker in two places, as shown. The shelf stand screws may be found in Hardware Bag A. Use the larger screw in the upper screw hole, and the smaller screw in the lower screw hole.

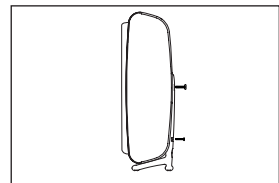
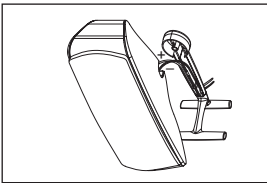

MOUNTING THE SATELLITES ON OPTIONAL FLOOR STANDS

Important Safety Note: *The supplied floor stand adaptors facilitate installation with a variety of general purpose floor stands available from many manufacturers. Since different stands will have different weight capacities and stability characteristics, it is the customer's responsibility to check with the stand manufacturer or dealer whether that specific stand is capable of handling the weight and proportions of these loudspeakers in a safe and stable manner. JBL disclaims any liability for the selection of suitable floor stands and/or correct compat-*

ibility between the selected stand and these satellite loudspeakers.

The floor stand adaptors are compatible with floor stands equipped with a 1/4"-20 threaded insert.

Prepare the speaker wire as described on page 7. Thread the two conductors through the two holes in the floor stand

adaptor. Make sure to preserve the proper polarity (+ and – connections) by threading the positive conductor through the hole on the left, and the negative conductor through the hole on the right looking at the front of the adaptor. Push down on the red speaker terminal and insert the bare end of the positive wire into the hole under the red cap. Release the cap, and tug gently on the wire to make sure that the connection is snug. Follow the same procedure to connect the negative wire to its terminal.

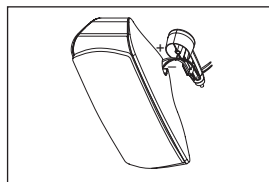

Gently pull the slack out of the wire and screw the adaptor onto the back of the speaker in two places, as shown.

The floor stand adaptor screws may be found in Hardware Bag B. Use the larger screw in the upper screw hole, and the smaller

screw in the lower screw hole. Screw the floor stand adaptor into the floor stand's threaded insert until the speaker is firmly attached to the stand. Back off slightly from the fully-tightened position until the speaker is oriented as desired, then rotate the thumbwheel at

the bottom of the floor stand adaptor to secure the speaker to the stand.

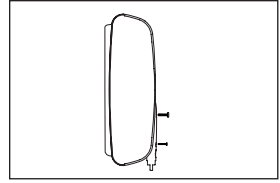

WALL-MOUNTING

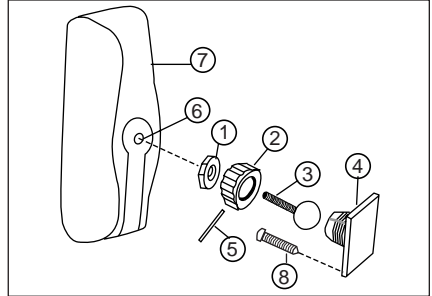
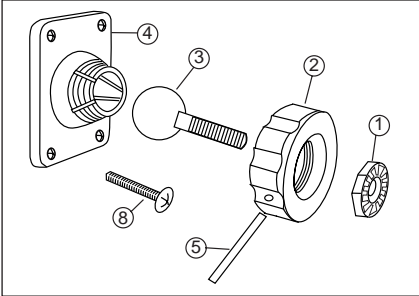

Important Safety Note: The customer is solely responsible for proper selection of mounting hardware not included with the speakers, and for proper assembly and installation of the wall-brackets, including but not limited to the selection of appropriate weight-bearing supports and proper use of the bracket. JBL disclaims any liability for the selection of mounting hardware and/or bracket installation. Be sure to follow these bracket assembly and installation instructions carefully. If you have any questions or doubts about your ability to correctly wall-mount the speakers, consult with your authorized JBL dealer or custom installer.

Step 1: Unscrew and remove the large **Molded Nut 2**. If necessary, use the supplied **Metal Bar 5** as a lever by

inserting it into one of the holes in the outer edge of the **Molded Nut 2**.

Step 2: Firmly grasp the **Ball and Shaft 3** and pull it straight out of the **Attachment Plate 4**. Avoid leaning it to the side for leverage, as this may break off a tab.

Step 3: Slide the **Molded Nut 2** onto the **Ball and Shaft 3** with the threaded opening facing the ball. Thread the **Metal Nut 1** all the way onto the **Ball and Shaft 3**, with the star washer side away from the ball. Refer to the exploded drawing for the proper orientation of these parts.

Step 4: Screw the **Ball and Shaft 3** into the **Threaded Insert 6** on the back of the **Satellite Speaker 7** until it is fully seated in the **Threaded Insert 6**, but *do not* tighten as you might dislodge the **Threaded**

Insert 6. Such damage would not be covered under the warranty.

Step 5: Tighten the **Metal Nut 1** with the star washer side between the **Metal Nut 1** and the back of the **Satellite Speaker 7**, using large needle-nose pliers, until it is firmly seated against the back of the **Speaker 7** and has locked the **Ball and Shaft 3** and the **Satellite Speaker 7** together. Note that once the **Metal Nut 1** is fully tightened, it may embed some marks on the back of the **Satellite Speaker 7**. However, these marks will be covered by the **Metal Nut 1**.

Step 6: Mount the **Attachment Plate 4** into a wood stud on the wall, using four #10 pan-head wood screws at least one inch long (not supplied) **8**. Make sure that all four screws are driven

into the stud and not into drywall. *If the bracket needs to be mounted in drywall, the customer is responsible for selecting and using appropriate wall-anchors and screws.*

Important Note: The **Metal Nut 1** must be fully tightened against the **Satellite Speaker 7** as described in Step 5 before beginning Step 7 in order to avoid damage to the **Threaded Insert 6**. Such damage would not be covered under the warranty. Step 7: Holding the **Satellite Speaker 7** with both hands, reinsert the ball portion of the **Ball and Shaft 3** into the **Attachment Plate 4**. Step 8: Hand-tighten the

Molded Nut 2 while positioning the speaker for the desired orientation. If the **Molded Nut 2** is difficult to tighten by hand, insert the **Metal Bar 5** into one of the holes in the outer edge of the **Molded Nut 2** and use the bar as a lever. Be careful not to cross-thread. The swiveling ball enables you to aim the speaker to one side or the other, or to tilt it up or down. Stereo imaging may be improved by aiming the front speakers toward the listening position, especially for music selections. In Dolby Digital and DTS systems, it is best to aim all of the speakers (except the subwoofer) toward the lis-

tening position at about ear-level height. In systems where only analog surround processing (such as Dolby Pro Logic) is available, it may be preferable to aim the speakers straight out from the wall to obtain a more diffuse sound. Step 9: Once the speaker's orientation has been finalized, insert the **Metal Bar 5** into one of the holes in the outer edge of the **Molded Nut 2** and tighten the **Molded Nut 2** securely. Keep the **Metal Bar 5** in a safe place in the event that you decide to adjust the speaker's orientation in the future.

SPEAKER CONNECTIONS

CONNECTION TIPS

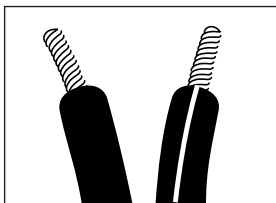

Separate and strip the ends of the speaker wire as shown. The wires supplied with the system may already be stripped and tinned for easy insertion into the speaker terminals. You may need to separate the two conductors further in order to thread them through the shelf stand or floor stand adaptor. Speakers and electronics terminals have corresponding (+) and (-) terminals. Most manufacturers of speakers and electronics, including JBL, use red to denote the (+) terminal and

black to denote the (-) terminal.

The (+) lead of the speaker wire is noted with a stripe. It is important to connect both speakers identically: (+) on the speaker to (+) on the amplifier and (-) on the speaker to (-) on the amplifier. Wiring "out of phase" results in thin sound, weak bass and a poor stereo image.

With the advent of multi-channel surround sound systems, connecting all of the speakers in your system with the correct polarity remains equally important in order to preserve the proper ambience and directionality of the program material.

To connect the supplied speaker wires to the satellite and center speaker terminals, press the red or black plastic cap for the desired

terminal, insert the bare end of the wire into the hole below the cap and release the cap. Gently tug on the wire to make sure that it is fully inserted.

To use the binding-post speaker terminals on the subwoofer, unscrew the colored collar until the pass-through hole in the center post is visible under the collar. Insert the bare end of the wire through this hole; then screw the collar down until the connection is tight. The hole in the center of each collar is intended for use with banana-type connectors. To comply with European CE certification, these holes are blocked with plastic inserts at the point of manufacture. To use banana-type connectors requires the removal of the inserts.

DOLBY® DIGITAL OR DTS® (OR OTHER DIGITAL SURROUND MODE) CONNECTION

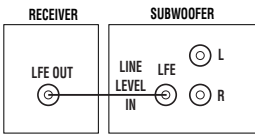

Use this installation method for Dolby Digital, DTS or other digital surround processors:

Use the line-level input jack marked "LFE" for the Low-

Frequency Effects channel. Connect this jack to the LFE output or subwoofer output on your receiver or amplifier. Connect each speaker to the corresponding speaker terminals on your receiver or amplifier.

Make sure that you have configured your surround sound processor for "Subwoofer On." Also configure

your receiver for 5.1-, 6.1- or 7.1-channel operation as appropriate. The front left, front right, center and rear speakers should all be set to "Small." If your receiver allows you to set the crossover frequency between the subwoofer and the main speakers, select 100Hz or the setting that is the closest frequency below it.

DOLBY PRO LOGIC® (NON-DIGITAL) - LINE LEVEL

Use this installation method for Dolby Pro Logic applications (not Dolby Digital, DTS or other digital processing), where the receiver/processor is equipped with a subwoofer output, or a volume-controlled preamp (line-) level output:

Use RCA-type interconnects to connect the line-level subwoofer outputs on your receiver or amplifier to the line-level inputs on the subwoofer. **IMPORTANT:** Do not use the LFE input on the subwoofer with Dolby Pro Logic processors.

NOTE: If your receiver or amplifier only has one subwoofer output jack, then you will need to use a Y-connector (not included). Plug the male end of the Y-connector into your receiver or amplifier's subwoofer output jack, and connect each of the two female ends to separate RCA-type interconnects. Finally, plug the RCA-type interconnects into the line-level inputs on the subwoofer.

Connect each speaker to the corresponding speaker terminals on your receiver or amplifier.

Make sure your receiver or processor is correctly configured to indicate that the subwoofer is "On."

Note for advanced users: If your receiver/processor has a built-in low-pass crossover filter for the subwoofer output, you may use the LFE input to bypass the subwoofer's internal crossover.

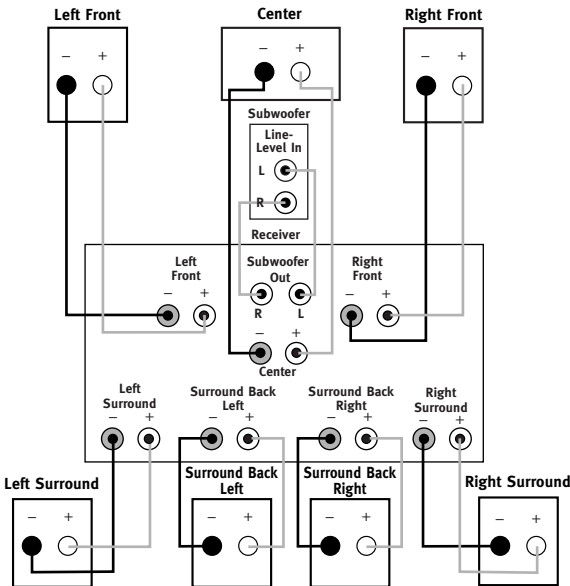

DOLBY PRO LOGIC (NON-DIGITAL) – SPEAKER LEVEL

Use this installation method for Dolby Pro Logic applications (not Dolby Digital, DTS or other digital processing), where the receiver/processor does not have a subwoofer output, or a volume-controlled preamp (line-) level output:

Connect your receiver or amplifier's front left and right speaker terminals to the left and right terminals on the subwoofer that are marked "Speaker Level In." Connect the left and right terminals on the subwoofer that are marked "Speaker Level Out" to the corresponding terminals on the back of your front left and right speakers.

Connect your receiver or amplifier's center, surround and surround back speaker terminals to the corresponding terminals on the back of your center and surround speakers.

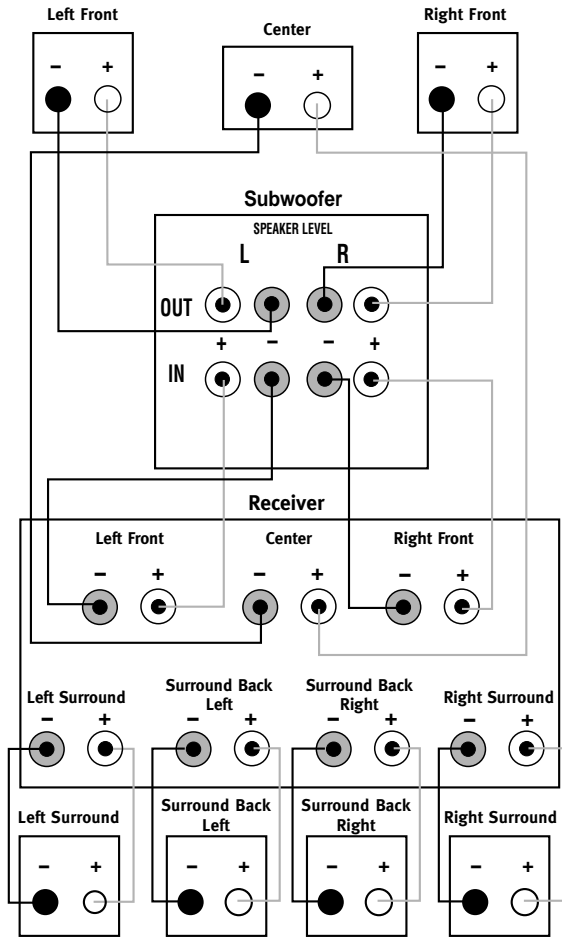

OPERATION

Move the Master Power switch (marked "Power" **A**) to the "•" (On) position to use the subwoofer. The SUB300 subwoofer will automatically turn on or go into standby (sleep) mode when left in the auto mode ("Auto/On" switch **C** in the "Auto" position). When your receiver or amplifier is off, or is not sending program material to the subwoofer, the subwoofer will be in standby mode (LED will be red). When the subwoofer senses an audio signal, it will automatically turn on (LED will be green). If the subwoofer does not sense a signal after approximately 20 minutes, it will automatically go into standby mode.

When the "Auto/On" switch **C** is switched to the "On" position, the subwoofer will remain on, whether or not program material is playing.

If you will be away from home for an extended period of time,

or if the subwoofer will not be used, switch the Master Power switch **A** to the Off position.

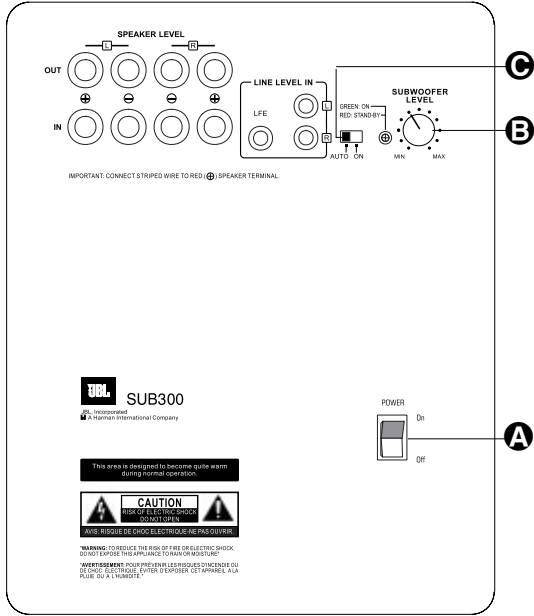

VOLUME

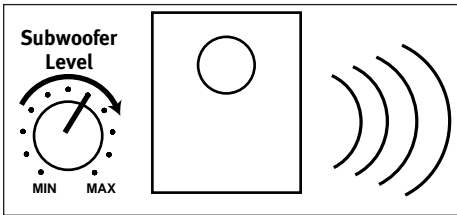

Volume may be adjusted using the Subwoofer Level control **B** as shown.

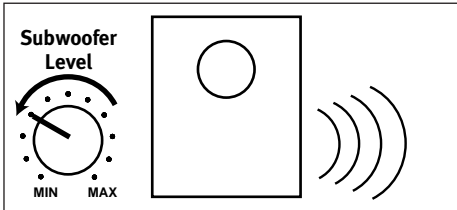

TROUBLESHOOTING

If there is no sound from any of the speakers:

- Check that receiver/amplifier is on and a source is playing.
- Check that the powered subwoofer is plugged in, and its Power switch **A** is switched on (“•” position).
- Check all wires and connections between receiver/amplifier and speakers. Make sure all wires are connected. Make sure none of the speaker wires are frayed, cut or punctured, or touching each other.
- Review proper operation of your receiver/amplifier.

If there is no sound coming from one speaker:

- Check the “Balance” control on your receiver/amplifier.
- Check all wires and connections between receiver/amplifier and speakers. Make sure all wires are connected. Make sure none of the speaker wires are frayed, cut or punctured, or touching each other.
- In Dolby Digital or DTS modes, make sure that the receiver/processor is configured so that the speaker in question is enabled.
- Turn off all electronics and switch the speaker in question with one of the other speakers that is working correctly. Turn everything back on, and determine whether the problem has followed the speaker, or has remained in the same channel. If the problem is in the same channel, the source of the problem is most likely with your receiver or amplifier, and you should consult the

owner’s manual for that product for further information. If the problem has followed the speaker, consult your dealer for further assistance or, if that is not possible, visit www.jbl.com.

If there is no sound from the center speaker:

- Check all wires and connections between receiver/amplifier and speaker. Make sure all wires are connected. Make sure none of the speaker wires are frayed, cut or punctured, or touching each other.
 - If your receiver/processor is set in Dolby Pro Logic mode, make sure the center speaker is not in phantom mode.
 - If your receiver/processor is set in one of the Dolby Digital or DTS modes, make sure the receiver/processor is configured so that the center speaker is enabled.
- ## **If the system plays at low volumes but shuts off as volume is increased:**
- Check all wires and connections between receiver/amplifier and speakers. Make sure all wires are connected. Make sure none of the speaker wires are frayed, cut or punctured, or touching each other.
 - If more than one pair of main speakers is being used, check the minimum impedance requirements of your receiver/amplifier.

If there is low (or no) bass output:

- Make sure the connections to the left and right “Speaker Inputs” have the correct polarity (+ and –).
- Make sure the subwoofer is plugged into an active

electrical outlet, and is turned on (Power switch **A** in the “•” position).

- In Dolby Digital or DTS modes, make sure your receiver/processor is configured so that the subwoofer and LFE output are enabled.

If there is no sound from the surround speakers:

- Check all wires and connections between receiver/amplifier and speakers. Make sure all wires are connected. Make sure none of the speaker wires are frayed, cut or punctured, or touching each other.
- Review proper operation of your receiver/amplifier and its surround sound features.
- Make sure the movie or TV show you are watching is recorded in a surround sound mode. If it is not, check to see whether your receiver/amplifier has other surround modes you may use.
- In Dolby Digital or DTS modes, make sure your receiver/processor is configured so that the surround speakers are enabled. When five satellites are in use, remember to configure your receiver or processor for 6.1-channel operation, and when all six satellites are in use, configure your receiver or processor for 7.1 channels.
- Review the operation of your DVD player and the jacket of your DVD to make sure that the DVD features the desired Dolby Digital or DTS mode, and that you have properly selected that mode using both the DVD player’s menu and the DVD disc’s menu.

SPECIFICATIONS

SCS300.7 System

Frequency Response
30Hz – 20kHz (–6dB)

Satellites

Maximum Recommended Amplifier Power
100 Watts

Nominal Impedance 8 Ohms

Sensitivity 88dB @ 1 Watt/1 meter

Frequency Response 100Hz – 20kHz (–6dB)

Tweeter

One 1/2" (13mm) titanium-laminate dome,
video-shielded

Midrange

Dual 3" (75mm) drivers, video-shielded

Dimensions (H x W x D) (not including shelf stand)

11-1/2" x 4" x 3-1/2" (292mm x 102mm x 89mm)

Weight 3 lb (1.4kg)

Center

Maximum Recommended Amplifier Power
100 Watts

Nominal Impedance 8 Ohms

Sensitivity 88dB @ 1 Watt/1 meter

Frequency Response 100Hz – 20kHz (–6dB)

Tweeter

One 1/2" (13mm) titanium-laminate dome,
video-shielded

Midrange

Dual 3" (75mm) drivers, video-shielded

Dimensions (H x W x D) (not including shelf stand)

4" x 11-1/2" x 3-1/2" (102mm x 292mm x 89mm)

Weight 3 lb (1.4kg)

Subwoofer

Amplifier 150 Watts RMS

Frequency Response 30Hz – 120Hz (–6dB)

Woofer 10" (250mm)

Enclosure Bass-reflex

Dimensions (H x W x D) (including feet)

20" x 13-3/4" x 15-3/4"

(508mm x 349mm x 400mm)

Weight 35 lb (15.9kg)

All features and specifications are subject to change without notice.

*Trademarks of Dolby Laboratories.

DTS is a registered trademark of Digital Theater Systems, Inc.

OWNER'S GUIDE

PRODUCT LINE:

SURROUND CINEMA SPEAKERS

MODEL: SCS300.7

DESIGN GOAL: Bring the thrill of live performance and movie sound to the home environment by calling on JBL's professional engineering leadership.

SATELLITE TYPE: Titanium-laminate-dome tweeter,
sealed enclosure

SUBWOOFER TYPE: Bass-reflex enclosure

PORT DESIGN: FreeFlow™ flared

PROFESSIONAL REFERENCE: Cinema Loudspeaker Series

JBL

PRO SOUND COMES HOME™

JBL Consumer Products
250 Crossways Park Drive, Woodbury, NY 11797
8500 Balboa Boulevard, Northridge, CA 91329
516.255.4JBL (4525)
www.jbl.com

© 2004 Harman International Industries, Incorporated

JBL is a registered trademark of
Harman International Industries, Incorporated.

Part No. 406-000-0059 

H A Harman International Company